

# V1

## User Manual

Information in this manual  
is subject to change without notice.

[www.rexingusa.com](http://www.rexingusa.com)

©2019 REXING All Rights Reserved

Rev.A05/2019

# More About REXING

Want to know more about  
REXING?

Check us out here!

<https://www.facebook.com/rexingusa/>

<https://www.instagram.com/rexingdashcam/>

<https://www.rexingusa.com/support/registration/>

Facebook



Instagram



Website



# Table of Contents

1.About This Manual	01
2.What's in the Box	02
3.Camera Overview	04
4.Getting Started	07
4.1 Installing the Dash cam Mount	07
4.2 Insert the Memory Card	08
4.3 Power the Camera and Format Memory Card	10
4.4 Installing the Camera onto the Windshield	13
5.Basic Operation	15
5.1 Device Power	15
5.2 Menu Settings	16
5.3 Display Control	17
5.4 Video Recording	18
5.5 Video Playback	18
5.6 GPS Playback	21
5.7 Taking Photos	26
5.8 Wi-Fi Connect	28
6.Mode Setup	29
6.1 Video Mode Settings	29
6.2 Parking Monitor Settings	33
6.3 System Setup Settings	35
6.4 Photo Mode Settings	39
7.Updating the Firmware	45
8.Product Specifications	47
9.Warranty and Support	48

# 1

## About This Manual

This user manual describes the device's functions and features in detail. Please note the following:

- Images, screenshots and contents may differ in appearance from the actual product or software provided by service providers, and are subject to change without prior notice.
  - Available features and additional services may vary by device and software.
  - Applications and their functions may vary by country, region, or hardware specifications.
- REXING is not liable for performance, incompatibility issues, data corruption or loss caused by (a) applications from any providers other than REXING, (b) failure to install the device as stated in this manual the following, (c) attempting to customize the installation. These actions are violations of your REXING agreement and will void your warranty.
  - Default applications that come with the device are subject to updates and possible discontinuation of support without prior notice.
  - Do not distribute copyright-protected material. Doing so without the permission of the content owners may violate copyright laws. The manufacturer is not responsible or liable for any legal issues that result from the user's illegal use of copyrighted material.



# 2

## What's in the Box?

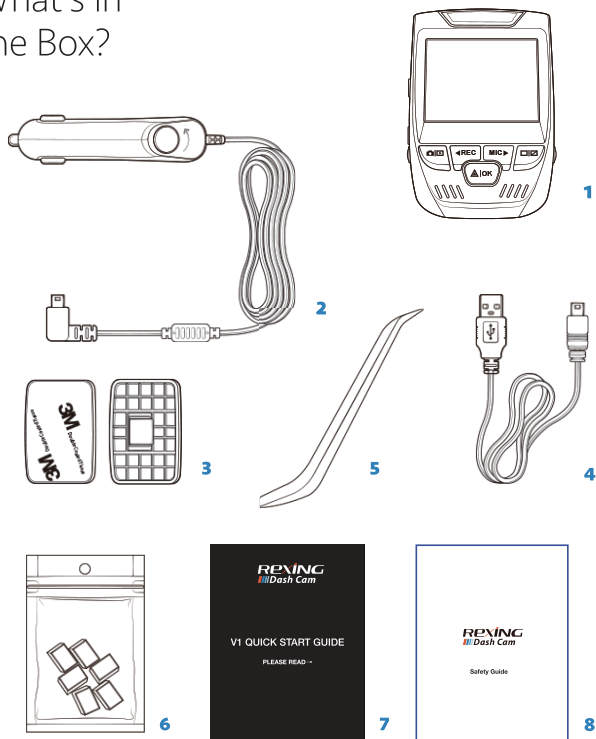

No.	Name
1	Rexing V1 Dash Cam
2	Car Charger
3	Dash Cam Mount Plate & 3M Adhesive
4	Mini-USB Cable
5	Cable Management Tool
6	Cable Clips©
7	V1 Quick Start Guide
8	V1 Safety Guide

The items supplied with the device and any available accessories may vary depending on your region. Appearances and specifications are subject to change without prior notice.

Availability of all accessories is subject to change. All supplied items are designed for use only with this device and may not be compatible with other devices. Malfunctions resulting from the use of unapproved accessories are not covered by the warranty service.

For more information about available accessories, refer to [www.rexingusa.com](http://www.rexingusa.com).

# 3

## Camera Overview

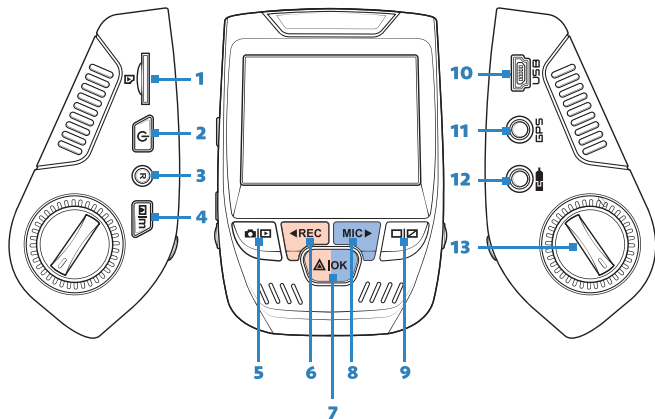

No.	Name	Description
1	Micro SD Card Slot	Insert the Micro SD card into this slot.
2	POWER Button	Hold this button to turn the Dash Cam On or Off.
3	RESET Button	Hold this button for four seconds to reset the Dash Cam to the factory settings.
4	MENU Button	Press this button to enter the setup menus.
5	MODE Button	Press this button to select the Video, Photo, Playback modes or stop video playback.
6	REC Button	Press this button to (a) Enable or disable video recording or (b) Toggle up through recorded video, photos and menu options. <b>Note:</b> The camera is recording when the LED is flashing red. By default, video recording is set to On.
7	OK Button	Press this button to accept a menu selection or set the emergency lock. <b>Note:</b> The camera is recording when the LED is flashing red. The device is charging or powered on when the LED is solid blue.
8	MIC Button	Press this button to (a) Enable or disable audio recording or (b) Toggle down through recorded video, photos and menu options. <b>Note:</b> The device is charging or powered on when the LED is solid blue. By default, audio recording is set to Off.
9	SCREEN Button	Press this button to turn the screen On or Off.
10	Mini-USB Port	Connect the USB to Mini-B 5pin Male cable to this port.
11	GPS Logger Port	Connect the Rexing GPS Logger to this port.
12	Rear Camera Port	Connect the Rear Camera to this port.
13	Lens Angle Adjustment	Turn the dial to set the position of the camera.

# Screen Overview

Reference the following screens to identify icons and text displayed on a screen.

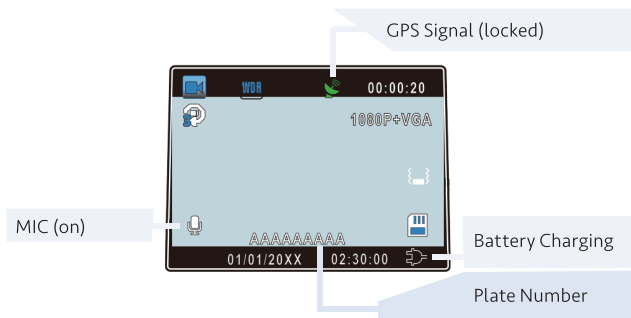
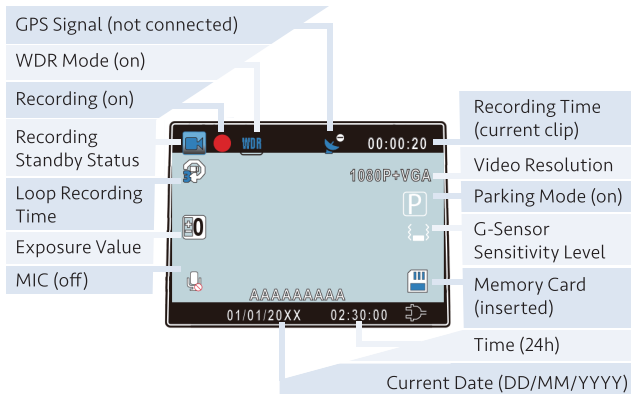

# 4

## Getting Started

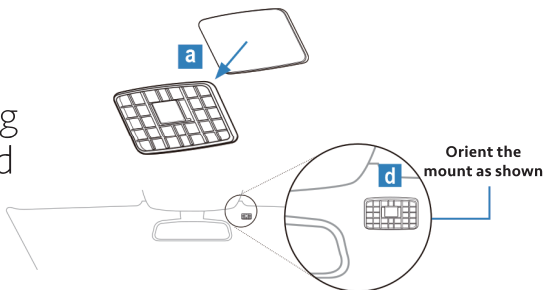

### 4.1

#### Installing the Dash Cam Mount

Follow these steps to install the Mount on the vehicle's front window. **Note:** Ensure the distance from of the Mount and Car Charger is less than 12 feet.

- a. Place the 3M tape on the Mount. **Note:** Do not remove the release liner on the opposite side of the tape.
- b. Select, and clean, the location for the Dash Cam on the windshield.  
**Important!** Choose a safe, appropriate location that does not obstruct the driver's view.
- c. Remove the release liner from the 3M tape.
- d. Properly orient the Mount and square it up to the roof and hood line of the vehicle. **Important!** Ensure the

T-interlock on the Mount is oriented in the correct direction. Firmly press the Mount onto the windshield.

- e. Wait **at least 20 minutes** before attaching the Dash Cam to the Mount.

## 4.2

### Insert the Memory Card

#### NOTE

Using an incompatible card may damage the device, the memory card, or corrupt the data stored on it. Always use a compatible memory card.

Always power down the device before removing the memory card. The manufacturer's warranty does not cover any losses, including loss of data, due to the use of a damaged, or corrupt, memory card.

This device accepts "High-endurance" Micro SD memory cards (class 10 or higher) with a maximum capacity of 256GB.

Depending on the memory card manufacturer and type, some cards may not be compatible with the device. Visit [www.rexingusa.com/memory-card](http://www.rexingusa.com/memory-card) to view recommended cards.

Follow these steps to **insert the memory card** into the device.

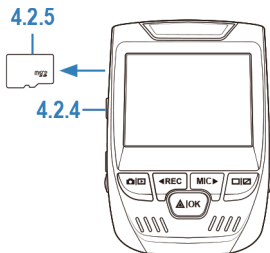
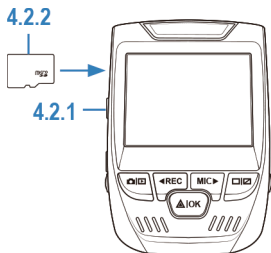

#### 4.2.1

Press and hold the Power button to turn the camera Off.

#### 4.2.2

Insert the card in the orientation show.

#### 4.2.3

Listen for the click sound that signals the card is securely inserted.

Follow these steps to **remove the memory card** from the device.

**Important!** Do not remove the memory card while the device is transferring or accessing information.

#### 4.2.4

Press and hold the POWER button to turn the camera Off.

#### 4.2.5

Gently push the memory card in until you hear a click, and allow the spring release to push the card out.



## 4.3

Power the Camera and Format the Memory Card

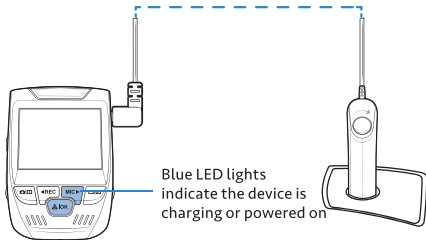

### 4.3.1

#### Charging the Battery

Connect your camera to your vehicle via the included car charging cable to power your camera and charge the battery while driving.

Connect the charger to the car cigarette lighter or 12V DC power outlet, then insert the Mini-USB end of the charger into the Mini-USB port on the camera.

- **You should always connect the camera to a power source while recording.** Our currently product is powered by super capacitor which means there is NO battery inside of the dash cam. Once dash cam is disconnected from the power source, the dash cam will shut down automatically in 5 seconds.
- If the device receives an unstable power supply while charging, the screen may

not function properly. If this happens, unplug the charger from the device.

- While charging, the device may heat up. This is normal and should not affect the device's performance or lifespan.
- If the device is not charging properly, take the device and the charger to an authorized Rexing Service Center or contact [care@rexingusa.com](mailto:care@rexingusa.com).

**Connecting the charger improperly may cause serious damage to the device. Any damage caused by misuse is not covered by the warranty.**

Use only Rexing approved chargers. **Using unapproved chargers or cables can damage the device or cause the battery to explode.**

### 4.3.2

#### Formatting the Memory Card

**Important!** Always backup important data stored on the memory card before formatting. For best results, format the memory card using the Format function on the camera. The manufacturer's warranty does not cover loss of data resulting from user actions.

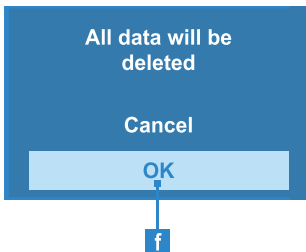
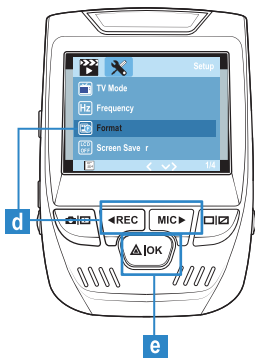
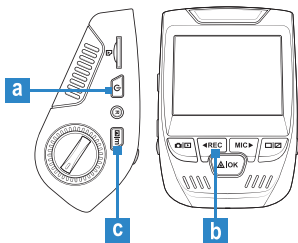

Always format the memory card correctly before using the new card. Follow these steps to format the memory card.

- a. Make sure you have inserted your memory card, then turn on the camera by connecting to a power source. **Note:** If the camera is On and not recording, go to Step C.
- b. Press the REC button to stop recording.
- c. Press the MENU button twice to enter the System Setup Menu.
- d. Use the REC and MIC buttons to navigate to the Format setting.
- e. Press the OK button to confirm the selection.
- f. Use the REC and MIC buttons and toggle to the OK option.
- g. Press the OK button to confirm and format the card.

At this point, disconnect from the power source. The camera will shut down automatically after 5 seconds. **The next time the camera is connected to power, the camera should start up and begin recording automatically.**

## 4.4

Follow these steps to install the camera.

### Installing the Camera onto the Windshield

#### 4.4.1

Insert the plastic mount piece into the open space located on the back of the camera and slide the camera down to secure it to the windshield.

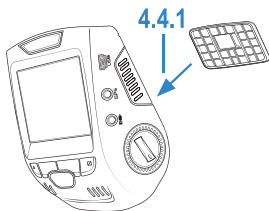

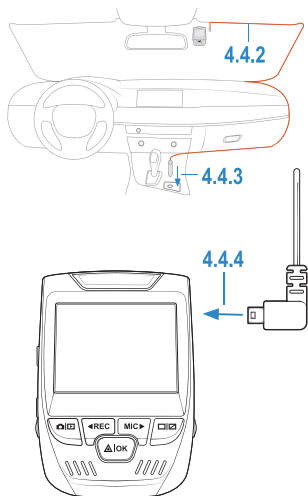

#### 4.4.2

#### 4.4.3

#### 4.4.4

Carefully route the power cable around the windscreen and tuck it under the trim. Plug the car charger cable into a 12V DC power outlet or the car cigarette lighter. Plug the charge into the Mini-USB port on the device. Start the vehicle. The camera will be auto powered on and start recording.

# 5

## Basic Operation

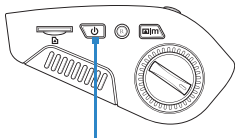

Press the POWER button to power the device on manually



The Red Dot, REC and OK button LED lights will blink red when the device is powered on and in video record mode.

### 5.1

#### Device Power

The device is automatically powered on when plugged into a 12V accessory socket or cigarette lighter and receives a charge (i.e.: the vehicle is started).

To turn the device on manually, press and hold the POWER button until the welcome screen appears.

Rexing V1 dash camera will switch on or off automatically if you keep it permanently connected to the car charger. V1 will automatically start recording when power on. After power is disconnected, the device will shut down after 5 seconds.

#### NOTE

The device will remain on when it is connected to a smart hardwire kit or cigarette lighter

socket that is receiving constant power. This may result in draining the vehicle battery. **If the car cigarette lighter provides constant power to the dash cam, the unit will not turn on or off with the vehicle.**

## 5.2

### Menu Settings

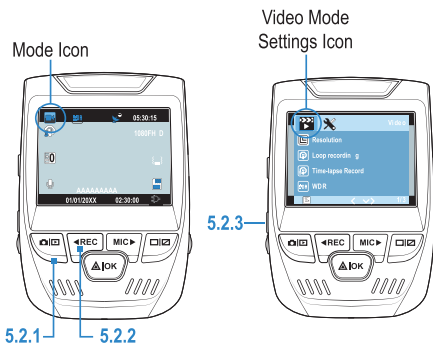

#### 5.2.1

Power the camera On. **Note:** If the device is On and in a different mode, press the MODE button and toggle to the desired mode.

#### 5.2.2

If the camera is recording, press the REC button to stop recording. If the camera is not recording, go to Step 3.

#### 5.2.3

Once in the desired mode (i.e.: Video), press the MENU button once to enter the settings menu for the mode. **Note:** To

## 5.2.4

access the System Settings press the MENU button twice when in any mode. Use the REC and MIC buttons and toggle to the desired setting.

## 5.2.5

Press the OK button to confirm the selection.

## 5.2.6

Use the REC and MIC buttons and toggle to the desired setting option.

## 5.2.7

After choosing the setting, press the MENU button to return to the current mode.

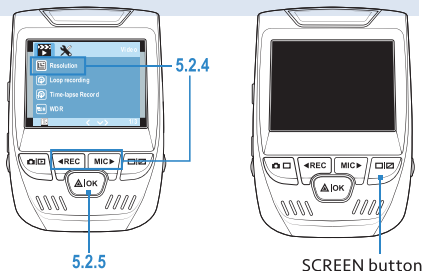

## 5.3

### Display Control

To reduce power consumption, press the SCREEN button to toggle the display on or off.

### NOTE

The camera will continue to record with the display off.



## 5.4

### Video Recording

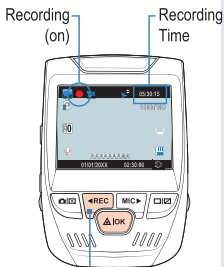

Press the REC button to stop recording

## 5.5

### Video Playback

The camera will automatically start recording when the device receives a charge (i.e.: the vehicle is started). When recording, the device will display a blinking red dot near the upper left corner of the screen. It will also show the time of the current recording in the upper right corner of the screen.

### Stop Recording

Video recording will automatically stop when the device isn't receiving a charge. It can also be stopped manually by pressing the REC button.

Playback of videos can be done on the device or a computer. Also, if you have purchased a REXING GPS Logger you may play back the recordings in a specialized application which allows you to view speed and location information alongside the footage.

### NOTE

Recommended media players include: QuickTime Media Player, VLC, Windows Media Player.

## 5.5.1

Mode Icon

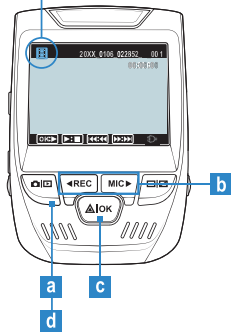

## Device Playback

Follow these steps to play back recordings on the device.

- Press the MODE button and toggle to the Playback Mode.
- Press the REC and MIC buttons to toggle through your videos.
- Press the OK button to play the selected video. During playback, press the OK button to pause the video.
  - During playback, press the MIC button one or more times (2X, 4X, 8X) to fast forward the video.
  - During playback, press the REC button one or more times (-2X, -4X, -8X) to rewind the video.
- Press the MODE button to stop play back.

## 5.5.1

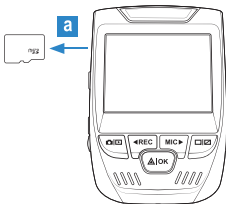

## Computer Playback

Video playback on a computer can be done using an SD Card Adapter or provided USB to Mini-B 5pin Male cable.

- Remove the Micro SD memory card from the device (see Installation 4.2).

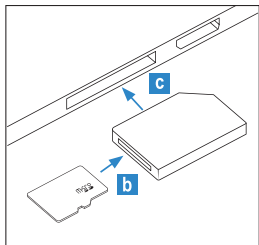

- b. Insert the Micro SD memory card into an SD Card Adapter.
- c. Insert the SD Card Adapter to the computer.
- d. On the computer, navigate to SD Card drive. The videos are stored at: \CARDV\MOVIE.
- e. Select the video to playback.

### Using the USB to Mini-B 5pin Male Cable

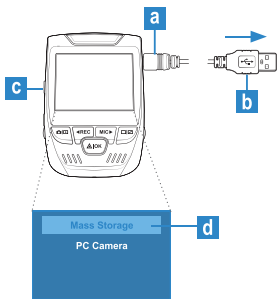

- a. Connect the USB to Mini-B 5pin Male Cable to the device.
- b. Connect the cable to a USB connector on the computer.
- c. Press the Power button and turn the device On.
- d. Press the OK button to select Mass Storage.
- e. On the computer, navigate to device drive. The videos are stored at:\CARDV\MOVIE.
- f. Select the video to playback.

### Locking Videos

Locking a video ensures the current video clip won't be overwritten by Loop Recording when the memory card is full.

This is important if a video clip needs to be saved for future use.  
To lock a video, press the OK button while in video recording mode.

## NOTE

Locked videos can be found on the memory card under: \CARDV\MOVIE\RO.

## 5.6

### GPS Playback

This feature is only available if you have the Rexing GPS Logger. The optional hardware, and software interface, provides additional information regarding your trip (i.e.: detailed location and speed information).

#### Installing the application

Install the external GPS hardware onto the windshield to void the interference, please make sure install the GPS Logger as far as you can away from the dash cam.

Follow these steps to activate the GPS Logger feature.

a. Press MENU button twice to enter the System Settings.

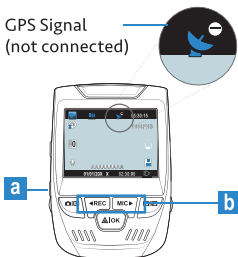



- b. Press the REC or MIC buttons and toggle to GPS Speed Unit.
- c. Press the REC or MIC buttons and select the Mi/H option.
- d. After a GPS signal is found, the screen icon will turn from blue to green.



You can review recorded video using The REXING GPS Video Player (available on: [rexingusa.com/support/productsupport/V1](http://rexingusa.com/support/productsupport/V1))

GPS function active



Once on the website, click the link titled Download GPS Logger software to download a zip folder containing the software installer. Unzip the folder to access the installer file contained within. Open the installer and follow the instruction to install the GPS Video Player to your computer. Once installed, you may launch the application.

## Opening a GPS Video File

Once you've opened the application, navigate to the top menu bar and click file > Open to browse through your files. Navigate to your video file you want to add to the playback queue, select it and click "Open" to load it into the application. You may also select multiple videos at once. After a brief loading period, the (first) video should begin playing back automatically, displaying speed and location information in real time along the right-side panels.

### Speed, location, date and time information

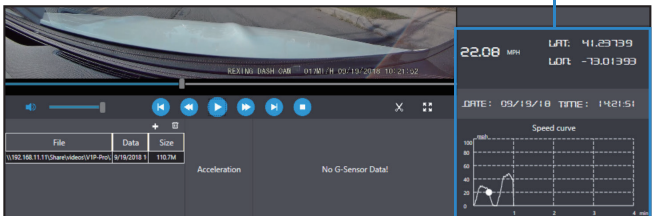

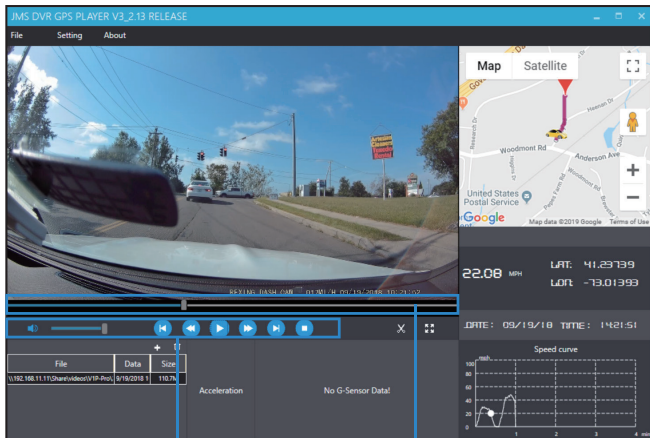

Volume Control Slider,  
Rewind, Pause/Play, Fast  
Forward, Next Stop buttons

Playback Bar

## Playback

Beneath the video is a playback bar with a handle which you can drag to skip to any time in the video. Beneath that, there's a volume control slider, as well as previous, rewind, pause/play, fast forward, next, and stop buttons.

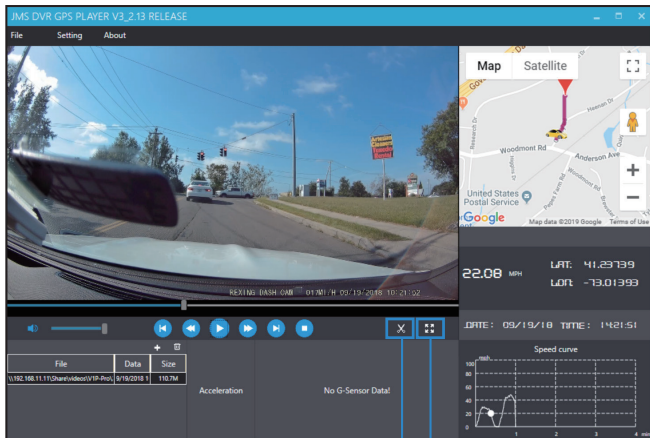

Snip Tool

Full Screen button

## Additional Controls

Snip Tool: Save the current frame of video as an image (PNG).

Full Screen button: View the video in full screen (double click the video to exit).

## NOTE

In the system settings menu, you may change your language and your unit of speed measurement from Mi/H to KM/H.



## 5.7

### Taking Photos

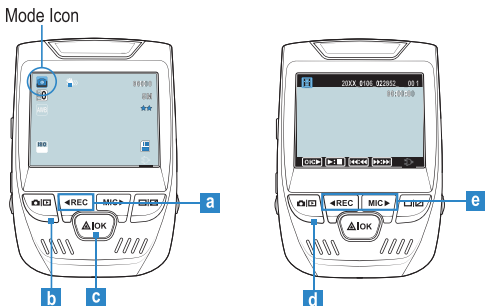

### 5.7.1

#### Taking and Viewing Photos

##### **Taking a Photo**

- Press the REC button to stop video recording.
- Press the MODE button and toggle to the Photo Mode.
- Press the OK button to take a photo.

##### **Viewing Photos**

- Press the MODE button and toggle to the Playback Mode.
- Press the REC and MIC buttons to toggle through your photos.

## 5.7.2

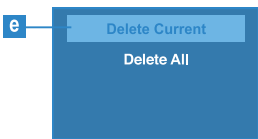

## Deleting Videos and Photos

Follow these steps to delete a single (Delete Current) or all (Delete All) videos and photos on the device.

- Press the MODE button and toggle to the Playback Mode.
- Press the REC and MIC buttons to toggle through your videos and photos to the one you want to delete.
- Press the MENU button to view the Playback settings.
- Press the MIC button to scroll down to the Delete option.
- Press the OK button and select Delete Current or Delete All.
- Press the MIC button to scroll down to the OK option.

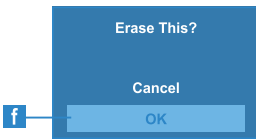

## 5.8

### Wi-Fi Connect

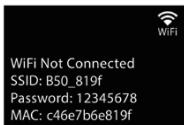
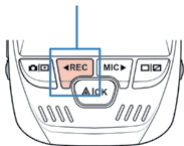

Download “Rexing Connect” app from the App Store or Google Play Store.



- To access or exit the Wi-Fi feature, hold down REC.
- Open Wi-Fi settings on your phone to find “SSID” from the list, tap to connect. (Default password: 12345678)
- Open the Rexing Connect app, tap “Connect” to enter the realtime video streaming page.
- Once connected, the dash cam screen will switch to the camera view and will display “Wi-Fi Connect” message. Using the Rexing Connect app, you can view a live preview of the dash cam screen, start/stop recording, as well as view and save your captures with your mobile device.

For further instruction regarding the Wi-Fi Connect feature, please visit

[www.rexingusa.com/wifi-connect/](http://www.rexingusa.com/wifi-connect/).

# 6

## Mode Setup

### 6.1

#### Video Mode Settings

#### NOTE

When in the Video Mode, press the MODE button once to enter the Video Mode settings.

Video Mode Icon

- 1 Press the Mode button *once* to enter the Video Mode settings.



Video Mode Settings Icon

- 2 Press the REC or MIC buttons to toggle through the settings.
- 3 Press the OK button to select the setting.



## 6.1.1

1080FHD 1920x1080

720P 1280x720

WVGA 848x480

VGA 640x480

Resolution

Default: 1080FHD

Select this setting to set video recording resolution.

Approximate recording time for each setting is as follows:

Memory Card Size	1080p Resolution	720p Resolution
32G	5 hours	10 hours
64G	11 hours	19 hours
128G	21 hours	39 hours
256G	42 hours	78 hours

## 6.1.2

Off

1 Minute

3 Minutes

5 Minutes

Loop Recording

Screed Icon: 

Default: 1 minute

Select this setting to have continuous video recording in 1, 3 or 5 minute segments.

### NOTE

When the storage limit is reached on the memory card, new recordings will

overwrite the oldest recording.

**Important!** Locked videos will NOT be overwritten by Loop Recording. Turning loop recording off would require you to manually clear recordings from your memory card whenever storage is full, thus **we highly recommend keeping loop recording enabled.**

### 6.1.3

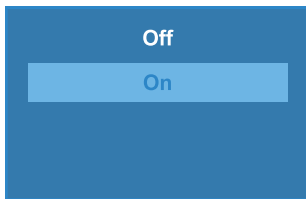

WDR (Wide Dynamic Range)

Screen Icon: 

Default: On

Select this setting to have the camera automatically adjust the exposure settings and provide balanced lighting and clearer video.

### 6.1.4

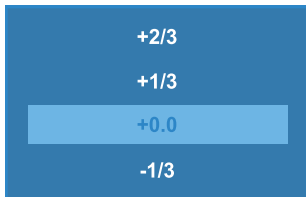

Exposure

Screen Icon: 



Default: +0.0

Select this setting to manually adjust the camera's exposure value and brighten or darken recordings. **Note:** Positive values brighten recordings, negative values darken them.

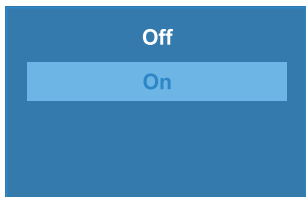
### 6.1.5



### Record Audio

Screen Icon:  

Select this setting to enable or disable the audio recording.

**Note:** This setting can be toggled On or Off by pressing the MIC Button.

### 6.1.6

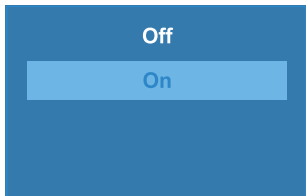

### Date Stamp

Default: On

Select this setting to stamp the date and time on the bottom of the video recording.

### 6.1.7

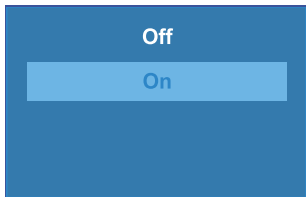

### Plate Number

Screen Icon: 

Default: On

Select this setting to enter the vehicle plate number and have it displayed on the bottom of the video recording. To enter your license plate number, use REC/MIC to change your current value, press OK to move to next value, press MENU to confirm setting.

## 6.1.8

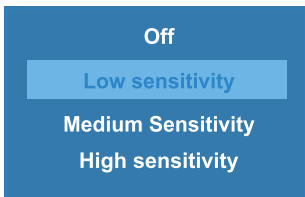

### Gravity Sensing

Screen Icon: 

Default: Low

Select this setting to initiate an automatic file lock on the current recording when a change in gravitation forces occurs, such as in a vehicular accident.

### NOTE

Locked videos are located on the memory at: \CARDV\MOVIE\RO. Locked video files will not be erased by loop recording, they will remain on the memory car until they are manually deleted, or when the card is formatted.

## 6.2

### Parking Monitor Setting

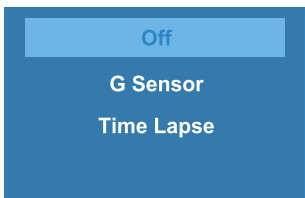

Screen Icon: 

Default: Off

- a. Connect the dash cam to the smart hardware kit (needs to be purchased separately) to activate the parking monitor function. Installation video could be found at [support.rexingusa.com/](http://support.rexingusa.com/).
- b. Once the parking monitor function is enabled, you can choose from G-Sensor mode or Time Lapse mode.



## G-Sensor

When a collision is detected while the car is parking, the camera will turn on and record a 20-second video clip, which will be locked securely from being overwritten.

**Pros:** G-Sensor mode is more energy efficient.

**Cons:** It may miss recording some videos in the sleep mode.

## Time Lapse

After the car is turned off, the dash cam will perform as usual, but the camera will capture videos and frames re-specified intervals of time and condense them into a video time lapse, which means your footage appears to be faster upon playback.

**Pros:** Dash cam will record everything after the car engine is turned off.

**Cons:** It may drain your car battery; however, the smart hardwire kit has low voltage protection function. When the smart hardwire kit detected low car battery, the dash cam will automatically shut down to protect your car battery.

## 6.3

### System Setup Setting

#### NOTE

When in any mode (i.e.: Video, Photo, Playback), press the MODE button twice to enter the System settings.

Video, Photo or Playback  
Mode Icon

- 1 Press the MODE button *twice* to enter the System settings.



System Settings Icon

- 2 Press the REC or MIC buttons to toggle through the settings.
- 3 Press the OK button to select the setting.



### 6.3.1

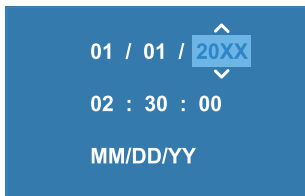

### Date/Time

Default: None

Select this setting to set the date, time and date/time format. To enter Date and Time, use REC/MIC to change your current value, press OK to move to next value, press MENU to confirm setting.

### 6.3.2

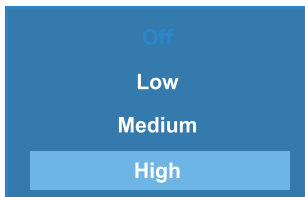

### Volume

Default: High

Select this setting to enable or disable the device sound effect.

### 6.3.3



### Language

Default: English

Select this setting to choose the menu language. **Note:** Additional language options not shown.

### 6.3.4

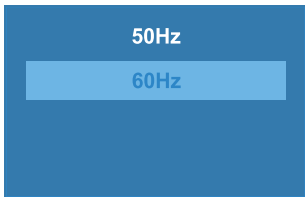

### Frequency

Default: 60Hz

Select this setting to choose the power supply specification used in a country or geographical region.

### NOTE

The power supply specification used in the United States is 60Hz.

### 6.3.5

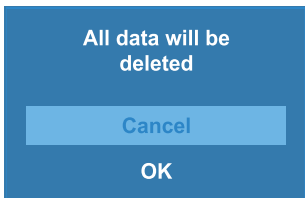

### Format

Select this setting to format the memory card. **Important!** Formatting the card will delete all files, including locked files. Be sure to back up any important footage or photos before formatting.

### 6.3.6

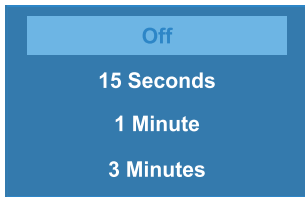

### Screen Saver

Default: Off

Select this setting to specify the duration of time the display will stay on after the device is powered on.

## NOTE

The screen saver may be toggled on or off using the SCREEN Button. The camera will continue to record with the display off.

### 6.3.7

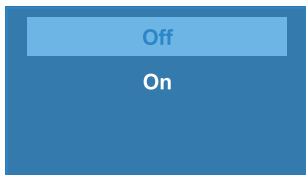

#### Daylight Saving

Default: Off

Select this setting to have the device adjust the time for Daylight Saving.

### 6.3.8



#### GPS Speed Unit

Default: mi/h

Select this setting to choose the units that speed information is displayed on the bottom of recordings.

**Note:** Requires GPS Logger.

### 6.3.9



#### Set Time Zone

Default: Off

Select this setting to update the time to the current time zone.

**Note:** Requires GPS Logger.

### 6.3.10

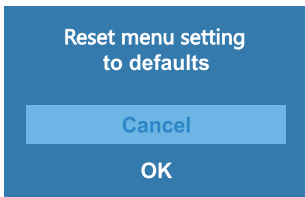

#### Default Settings

Default: None

Select this setting to reset all the settings to their default values.

### 6.3.11



#### Version

Default: None

Select this setting to see current firmware installed on the device.

## 6.4

### Photo Mode Settings

#### NOTE

When in the Photo Mode, press the MODE button *once* to enter the Photo Mode settings.

Photo Mode Icon

- 1 Press the Mode button *once* to enter the Photo Mode settings.



Photo Mode Settings Icon

- 2 Press the REC or MIC buttons to toggle through the settings.
- 3 Press the OK button to select the setting.



### 6.4.1



### Capture Mode

Screen Icon: 

**Note:** There is not a screen icon if Capture Mode is set to Single.

Default: Single Select this setting to set a timer that counts down before capturing images.

### 6.4.2



### Resolution

Screen Icon: 

Default: 5M

Select this setting to set the pixel resolution for captured images. **Note:** Higher resolution images are more detailed, but take up more space on the memory card.

### 6.4.3

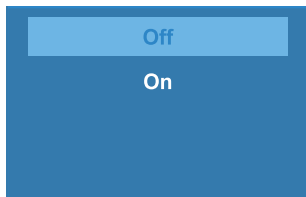

### Sequence

Default: Off

Select this setting to enable the camera to take three photos in rapid succession.



#### 6.4.4



Quality

Screen Icon: 

Default: Normal

Select this setting to set the quality level of captured images. **Note:** Lower quality images will use less space on the memory card but are more visually compressed.

#### 6.4.5

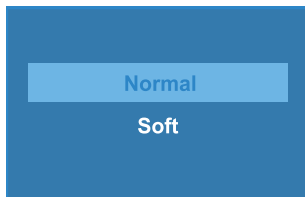

Sharpness

Screen Icon: None



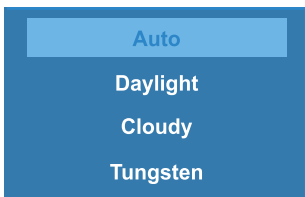

Default: NTSC

Select this setting to automatically enhance images for a clearer, more distinct picture.

#### 6.4.6



White Balance Screen

Icons: Auto  Daylight   
Cloudy  Tungsten 

Select this setting to adjust the white balance for different lighting conditions.

**Note:** When set to Auto the camera determines the appropriate white balance for each picture.

### 6.4.7

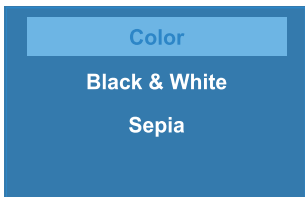

### Color

Default: Color

Select this setting to set the type of photo the camera will take. **Note:** Sepia is a black & white photo with a “warm” tone added.

### 6.4.8

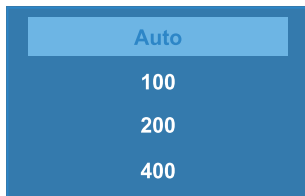

### ISO

Screen Icon: 

Default: Auto

Select this setting to adjust the camera’s sensitivity to light when taking pictures. **Note:** The higher the ISO, the better the camera operates in low light but images have a grainy appearance.

### 6.4.9

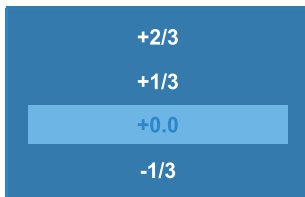

### Exposure

Default: +0.0

Select this setting to set the camera exposure value and brighten or darken the images.

#### 6.4.10

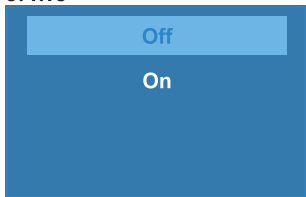

#### Anti-Shaking

Screen Icon:



Default: Off

Select this setting to automatically reduce the amount of blurriness in the images due to quick (shaky) movement.

#### 6.4.11

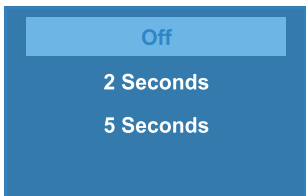

#### Quick Review

Default: Off

Select this setting to preview a photo and capturing it.

#### 6.4.12

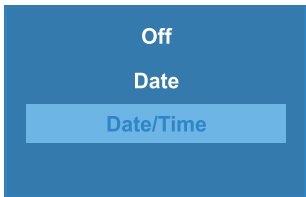

#### Date Stamp

Default: Date/Time

Select this setting to apply a date and/or time stamp to captured photos.

# 7

## Updating the Firmware

### NOTE

Installing incorrect firmware can damage your device. Identify the correct firmware for your camera by following the prompts at [www.rexingusa.com](http://www.rexingusa.com) firmware portal.

**We only recommend updating your firmware if you experience issues with the camera or updating for new features.**

To update the camera's firmware:

1. Format the memory card using the Format function (see Section 4.3.2 Formatting the Memory Card).
2. Take note of your firmware version number.
3. On a computer, visit the Firmware Section of [rexingusa.com](http://www.rexingusa.com) and follow the prompts to locate the correct firmware for your camera.
4. Download the firmware zip file to your computer.
5. Unzip the file.
6. Move the resulting file (.bin) to the root of your memory card.
7. Safely eject card from computer, then insert the card into the un-powered

camera.

8. Turn the camera on by connecting to a power source.
9. The camera will update automatically. The screen will stay off but the status light will stay on for up to 1 minute while the firmware updates.
10. After updating, format the memory card once more. Failure to do this will result in the camera attempting to update the firmware every time it's powered on.
11. After formatting, use the Power button to reboot the camera. Do not disconnect the camera from the power source.
12. Upon reboot, you may disconnect your camera from power.

# 8

## Product Specifications

Image Sensor	SONY EXMORIMX307 CMOS
Lens	7-layer fixed-focus with full-glass elements
CPU	Novatek
Display	2.4 inch, 4:3 TFT LCD
Audio I/O	Internal high-sensitivity mic and speaker
External Memory	Class 10 or higher Micro SD card (up to 256GB)
Gravity Sensor	Low / Medium / High / Off
Shutter	Electronic
White Balance	Auto
Exposure	Auto ISO
Super Capacitor	Built-in
Video Format	h.264 (.MOV)
Video Resolution	1920x1080p30f, 1280x720p30f
Languages	English, Chinese, French, Spanish, Portuguese, German, Italian, Russian, Japanese

# 9

## Warranty & Support

### Warranty

The Rexing V1 Dash Cam comes with a full 12 months warranty. If you register your product on our official site (<http://www.rexingusa.com/support/registration>) you can extend the warranty to 18 months.

### Support

If you have any questions regarding your product, please do not hesitate to contact us at [care@rexingusa.com](mailto:care@rexingusa.com), or call us at **(203) 800-4466**. Queries are typically answered within 12-24 hours.

### Your opinions matters

Rexing is firmly committed to always improving our products, services, and user experience. If you have any thoughts on how we can do even better, we welcome your constructive feedback and suggestions. Connect with us today at [care@rexingusa.com](mailto:care@rexingusa.com).

Thank you for choosing REXING!

# Enjoy Your Product!

[www.rexingusa.com](http://www.rexingusa.com)

**©2019 REXING All Rights Reserved**  
**Rev.A 05/2019**