

REXING[®]

P3 Mini User Manual

The information in this manual is subject to change without notice

www.rexingusa.com

01162025Rev

Activate Your 18-Month Warranty & Choose Your FREE Gift!

Activate within 30 days of purchase to claim your free gift and extend your limited 12-month warranty to 18 months.

Scan The QR To Activate &
Select Your Free Gift

**SCAN
ME!**



<https://www.rexingusa.com/productreg/>

About This Manual

This device provides high-quality digital recording using Rexing's high standards of design, construction and technological expertise. This user manual describes the device's functions and features in detail. Please read this manual before using the device to ensure safe and proper use. Note that all descriptions included here are based on the device's default settings.

- Images and screenshots may differ in appearance from the actual product. Content may differ from the final product or from software provided by service providers and is subject to change without prior notice.
- For the latest version of this manual, refer to the Rexing website at www.rexingusa.com/support/product-support
- Available features and additional services may vary by device and software.
- Applications and their functions may vary by country, region, or hardware specifications.
- Rexing is not liable for performance issues caused by applications from any provider other than Rexing.
- Rexing is not liable for performance issues caused by applications from any provider other than Rexing.
- Rexing is not liable for performance issues or incompatibilities caused by failure to install the device

as stated in this manual. Attempting to customize the installation may cause the device or applications to work improperly which may result in device malfunctions and data corruption or loss. These actions are violations of your Rexing agreement and will void your warranty.

- Default applications that come with the device are subject to updates and possible discontinuation of support without prior notice. If you have questions about an application provided with the device, contact an authorized Rexing Service Center.



/rexingusa



@rexingdashcam



www.rexingusa.com/support/registration/

Table of Contents

page

About This Manual	2
Table of Contents	4
1. What's in the box?	5
2. Camera Overview	7
3. LCD Screen Indications	9
4. Charging the Device	10
5. Basic Operation	12
6. Camera Shooting	18
7. Product Parameters	24
8. Troubleshooting	26
9. Name and Content Identification of Toxic or Harmful Substances or Elements	27
10. Warranty & Support	28

1. What's in the box?

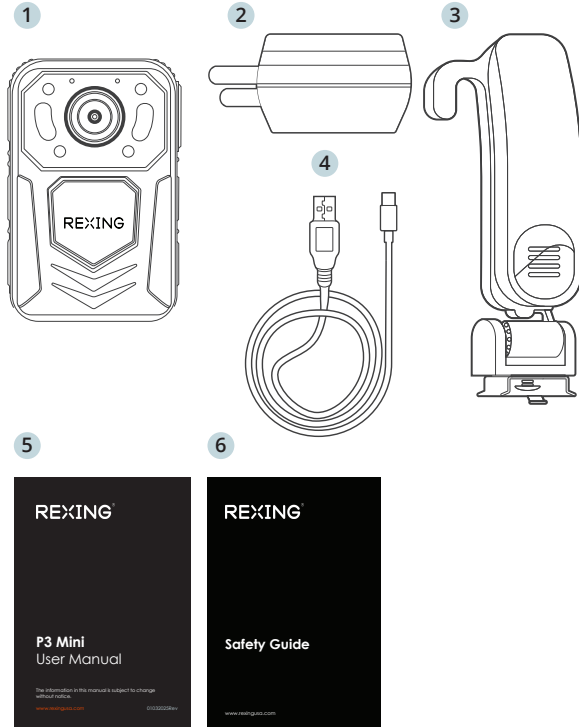

1. Rexing P3 Body Camera
2. Power Adapter
3. Shoulder Mount
4. USB Cable
5. User Manual
6. Safety Guide

The items supplied with the device and any available accessories may vary depending on region. Appearances and specifications are subject to change without prior notice. Availability of accessories is subject to change.

All supplied items are designed for use only with this device and may not be compatible with other devices. Malfunctions resulting from the use of unapproved accessories are not covered by the warranty service.

For more information about available accessories, refer to www.rexingusa.com

2.Camera Overview

Device Layout

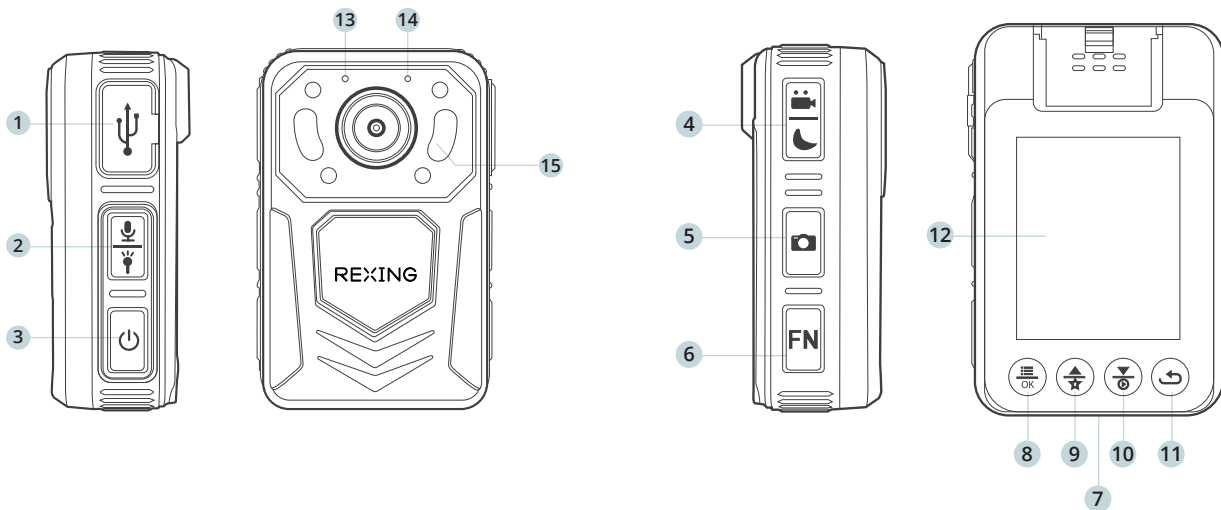

1. Type-C Charging Port
2. Voice Recording Button/ Hold to Activate White Light
3. Power On/Off Switch
4. Video Recording Mode/ Hold to Switch Night Vision Mode
5. Photo Capture Button
6. Siren Mode
7. Micro SD Slot

8. Menu/OK Button
9. Scroll Up/Rewind Button
10. Scroll Down/ Fast Forward Button
11. Back/Return Button
12. Display
13. Power Indicator Light
14. Charging Indicator Light
15. IR Light

3.LCD Screen Indications

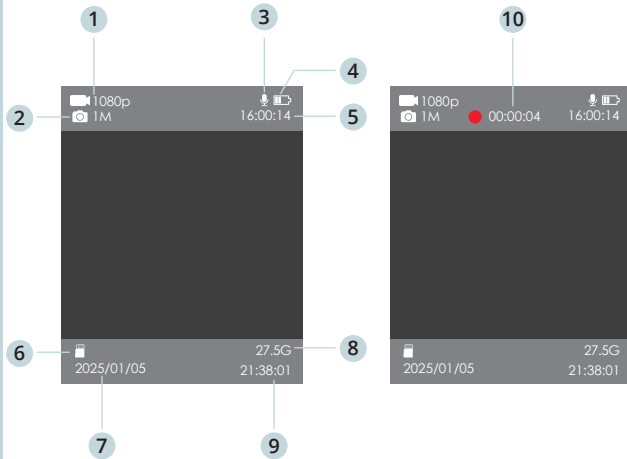

1. Video Resolution
2. Photo Resolution
3. Audio Recording Indicator
4. Battery Level Indicator
5. Memory Time Remaining
6. Memory Card Status
7. System Date
8. Memory Free Space
9. System time
10. Current Video Duration

4. Charging the Device

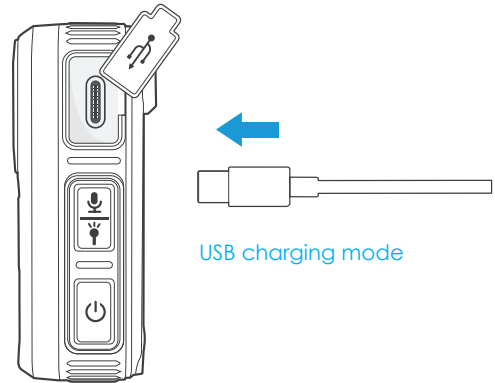

The device can be charged in the following two ways:

1. Connect the device to its charger where shown.
2. Connect the device to a computer.

As shown in the figure above, charge the device by connecting it to a computer with the USB cable. When charging, the power indicator light shows green, and the charging indicator light shows blue. The indicator lights extinguish after charging.

5. Basic Operation



Insert the Memory Card

The Rexing P3 accepts Class 10/ UHS-1 or higher Micro SD memory cards up to 128GB. You will need to insert a memory card before recording. Before inserting or removing a memory card, ensure you've powered down the device.

Gently push the memory card in until you hear a click, and allow the spring release to push the card out.

Power on the Camera and Format the Memory Card

Charge your dash for approximately 1-2 hr prior to the on-boarding process .

To ensure the P3 records your memory card properly and without error. Before you start using a new memory card, you must format the card within the camera using the format function. Always backup important data stored on the memory card before formatting.

To format the memory card, Navigate to system settings and select "Format SD card". Make sure you have inserted your memory card, then turn on the device by connecting to a power source.

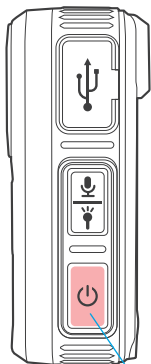

Power on

With the camera is in its power-off state, **press the ON/OFF key** to start the device. The device displays a preview screen after starting. The working indicator light turns green. If no operation is performed within 30 seconds after starting, the device enters screen saver mode as its default. The device automatically enters screen saver mode 30 seconds after it starts to shoot.

ON/OFF

Power off

With the camera in its power-on state, **depress the ON/OFF key** to power off the device. All indicator lights will extinguish. **Press the ON/OFF key** to enter screen saver mode.

Standby

With the camera in its power-on state, if no operation is performed within 30 seconds after starting, the device automatically enters screen saver mode; in this mode, the screen goes off and the working indicator light turns green. Press any key to illuminate screen.

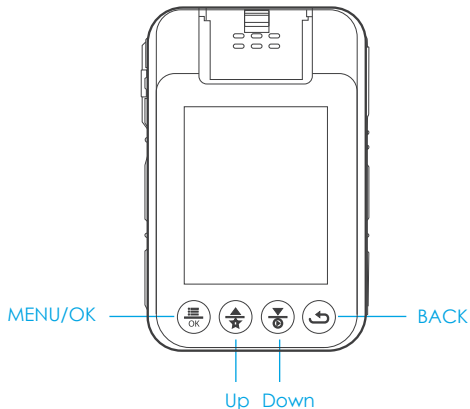

Menu Setup

With the camera in its standby state, **press the NEMU key** to enter the MENU setup interface. **Press the UP or DOWN key** to select the desired function. **Press the OK key** to confirm your option. Use the **UP or DOWN key** to change your option. **Press the OK key** again to confirm your selection(s). The device automatically saves any setup changes. Detailed system options are not described hereinafter. The screen display is shown below:

Menu	
Video Resolution	1080p
Photo Size	1M
Photo Bursts	Off
Post-Record	Off
Compress Store	Off
Loop Recording	Off

Video shoot resolution

Press the OK key to enter the to-be-altered function. **Press the UP or DOWN key** to select a value from the following: 1080p, 720p, 480p. The system default is 1080p.

Press the OK key to confirm your selection.

Photo Size

Press the OK key to enter the to-be-altered function. **Press the UP or DOWN key** to select a value from the following: 1M, 2M, 4M, 26M, 34M.

Press the OK key to confirm your selection.

IR Filter

Press the OK key to enter the to-be-altered function. **Press the UP or DOWN key** to select between Auto and Manual. The system default is Manual. **Press the OK key** to confirm your selection.

Video Length

Press the OK key to enter the to-be-altered function. **Press the UP or DOWN key** to select a value from the following: 5, 10, 15, 20 or 30 minutes.

Press the OK key to confirm your selection.

Voice prompt

Press the OK key to enter the to-be-altered function. **Press the UP or DOWN key** to select between ON and OFF. The system default is ON.

Press the OK key to confirm your selection.

Auto power-off

Press the OK key to enter the to-be-altered function. **Press the UP or DOWN key** to select a value from the following: 3, 5, and 10 minutes. The system default is 10 minutes.

Press the OK key to confirm your selection.

Loop recording

When this function is ON, old video files will be overwritten when memory is insufficient. **Press the OK key** to enter the to-be-altered function. You can select ON or OFF. The system default is OFF.

Press the OK key to confirm your selection.

Car Cam Mode

Press the OK key to enter the to-be-altered function. **Press the UP or DOWN key** to select between ON and OFF. The system default is OFF.

Press the OK key to confirm your selection.

Screensaver

When this function is **enabled**, the screen will be powered off at a set time. Press any key to restore power to the screen. **Press the OK key** to enter the to-be-altered function. **Press the UP and DOWN key** to select a value from the following: Off, 30 seconds, 1 minute, 2 minutes. The system default is 30 seconds.

Press the OK key to confirm your selection.

Default Setting

Press the OK key to enter the to-be-altered function. **Press the UP and DOWN key** to select between YES or NO. The system default is Cancel.

Press the OK key to confirm your selection.

Change Password

Press the OK key to enter the password entry function. The system default password is six zeros (000000). Input a password to modify it. **Press the UP or DOWN key** to key in specific inputs.

Press the OK key to confirm your password.

Police ID setup

Press the OK key to enter the password entry function. The system default password is six zeros (000000). Input current a password to change the police ID. **Press the UP or DOWN key** to key in specific inputs.

Press the OK key to confirm your password.

Time setup

Press the **OK key** to enter the password entry function. The system default password is six zeros (000000). Input your current password to modify the time. Press the **UP and DOWN key** to key in specific inputs.

Press the **OK key** to confirm your input.

Password

Press the **OK key** to enter the password entry function. The system default password is six zeros (000000). Input your current password to change machine mode. Press the **UP and DOWN key** to key in specific inputs.

Press the **OK key** to confirm your input.

Language

Press the **OK key** to enter the to-be-altered function. Press the **UP and DOWN key** to select between languages. The system default is English.

Press the **OK key** to confirm your selection.

Version

Press the **OK key** to view system information.

6.Camera Shooting

Camera shooting

Press the **VIDEO key** under the preview screen in the power-on state, or depress the **VIDEO key** for 3 seconds in the power-off state to start camera shooting. The red indicator light in upper right corner starts to flash slowly during recording, and, together with the red time indication, shows recording duration. The operating status indicating light turns red and starts to flash.

Press the **VIDEO key** again to stop camera shooting. The working indicator light turns green; the video file is automatically saved to the memory card, the screen goes back to shooting preview, and video file is saved to the memory card with a time indication and AVI as its suffix. To check the video, refer to the section Video Review/Play-

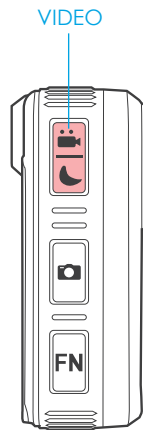

Video lockup

Press the **UP key** during camera shooting can lock up the current video. Press the **VIDEO key** again to unlock it. The camera shooting function is not interrupted during this process. A locked video cannot be deleted under the loop recording mode.

IR Night Vision Mode

Default IR night vision mode is a Manual function and the IR night vision indicator is off after starting the device. The optical filter switch uses a color filter, which is suitable for application at daytime. Use the optical filter switch to manually switch to IR night vision mode at night. In the power-on state, **hold the VIDEO key** under the preview screen to enable IR mode. Now the IR light is ON and shows red. The image changes into a black and white image under the preview screen or during camera shooting. **Hold the VIDEO key** again to turn off the IR mode. Now the IR light is OFF and the image restores color image under the preview screen or during camera shooting. **Hold the VIDEO key** allows you to switch between daytime working mode and night working mode. If automatic switching is desired, you may set the IR control to Auto in the menu. Now, the recorder may automatically switch to IR night vision mode according to ambient the brightness of light.

Deleting a File

You cannot delete any video file from the memory card by using the device itself. To delete a video file, you must connect the device to a computer and delete it from the USB drive via the computer.

Taking pictures

In the power-on state, **press the PHOTO key** under the preview screen to take a picture; the picture is saved automatically. There is an audible snap when taking a picture. A picture is taken with each press of the PHOTO key. These pictures are saved to the memory card with a time indication and JPG as the suffix. To check the pictures, refer to the section [Video Review/Playback](#).

Solo voice recording

In the power-on state, **press the RECORD key** under the preview screen or **depress the key for 3 seconds** to start solo voice recording. The screen shows a recording symbol during recording. The working indicator light turns orange and starts to flash. **Press the RECORD key** again to stop solo recording and the working indicator light turns green. The audio file is automatically saved to the memory card. The screen goes back to preview.

PHOTO

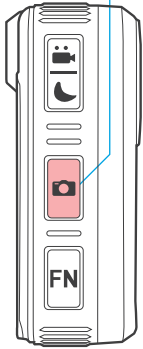

RECORD

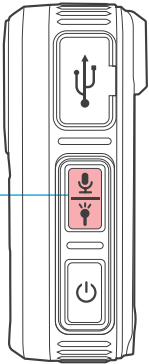

Videos and Photos Review/Playback

In the standby mode, **Press the DOWN key** to check the playback list. **Use the UP or DOWN key** to select a desired item as shown below:



Press the OK key to check the playback list. Use the UP or DOWN key to select a file to play.

During playback, **press the OK key** to pause or play. **Press the RETURN key** to return to the previous menu.

Computer Playback

When the device is connected with a computer via the USB Type-C cable, the computer will recognize the device as a USB Drive where you can find videos and photos are saved under two separate folders. Open the folder, and you'd be able to review the video/photo from the list.

Notes on the Indicators

1. In the power-on state, the power indicator is not shown in the preview screen.
2. In the power-on state, the working indicator light turns red and flashes slowly under camera shooting mode.
3. When the data cable is connected, the working indicator light turns green and the power indicator light turns blue.
4. In the charging state, the power indicator light turns blue and it extinguishes after charging.
5. In the power-on state, the power indicator light flashes during each shot.

Instruction for IR light, flashing light, and white light

In the power-on state, **hold the VIDEO key** to turn ON/OFF the IR indicator light, which is used to provided additional illumination when shooting at night. **Please make sure that the IR Switching is set to Manual to enable this function.**

In the power-on state, **hold the FN key** to turn ON/OFF the flashing light. The device alternately flashed a red and blue light in addition to sounding a warning alarm. This alarm functions in case of emergency.

In the power-on state, **hold the LIGHT key** to turn ON/OFF the white light. The device gives out a white light for illumination.

7. Product Parameters

Lens	F2.1 aperture, high resolution, multilayer filter, wide angle lens
Language Selection	Chinese/ English
Video recording	1080p 30FPS 720p 30 FPS 480p 30FPS (three adjustable levels)
Video rec. format	AVI
Video compression	H.264
Storage card	Support Up to 128G
Video bitrate	8 Mbit/sec
Power	5V/1A
Battery	Built-in
RAM capacity	See decal affixed on the device
Duration	Continuous working hours: 11 hrs Standby hours: 20 hrs

Protection grade	Expert
Fall impact grade	Withstands free-fall from a height of 1.5 m
Storage temp.	-40 °C ~+60 °C
Ambient temp.	-10~+45 °C (Recording and charging must not be performed in temperatures above 45 °C.)
Operating system	Windows XP/10/11 and Mac 10.5 or above

8.Troubleshooting

The device cannot be started, and it gives no response to any operation.

1. Connect the device to its charger and recheck its operation after charging for 4 hours.
2. Check the charger and its cable for any abnormalities.
3. If the problem persists, contact Rexing Support Team.

Flushing image

1. Switch off the device and restart it.

9. Name and Content Identification of Toxic or Harmful Substances or Elements

Toxic/Harmful Substances or Elements	LCD module	Circuit board assy	Battery	Shell and other components
Lead (Pb)	X	X	X	O
Mercury (Hg)	X	O	O	O
Cadmium (Cd)	O	O	X	O
Hexavalent chromiu (Cr6+)	O	O	O	O
Polynickel biphenyl (PBB)	O	O	O	O
Polybro-minated diphenyl ethers (PBDE)	O	O	O	O

O: Indicates that the content of toxic and hazardous substances in all homogeneous materials of the component is below the limit requirements specified in SJ/T 11363-2006.

X: Indicates that the content of toxic and hazardous substances in at least one homogeneous material of the component exceeds the limit requirement specified in SJ/T 11363-2006.

The environmental protection life of the complete unit is 10 years, and the environmental protection life of lithium battery module is 5 years.

10. Warranty & Support

Warranty

The Rexing P3 Body Cam comes with a full 12-month warranty. If you register your product on our official site (<https://www.rexingusa.com/support/registration>), you can extend the warranty to 18 months.

Support

If you have any questions regarding your product, please do not hesitate to contact us at care@rexingusa.com, or call us at (877) 740-8004. Queries are typically answered within 12-24 hours.

Your opinion matters

Rexing is firmly committed to always improving our products, services, and user experience. If you have any thoughts on how we can do even better, we welcome your constructive feedback and suggestions.

Connect with us today at care@rexingusa.com

Thank you for choosing Rexing!

This device complies with part 15 of the FCC Rules. Operation is subject to the following two conditions: (1) This device may not cause harmful interference, and (2) this device must accept any interference received, including interference that may cause undesired operation.

Changes or modifications not expressly approved by the party responsible for compliance could void the user's authority to operate this equipment.

REXING®

