

# REXING<sup>®</sup>

## R4-RD

### Quick Start Guide

The information in this manual is subject to change without notice.  
[www.rexing.com](http://www.rexing.com)

REV12302025

Activate Your

# 18-Month Warranty

& Unlock Exclusive Perks!

Activate within 30 days of purchase to  
**extend your limited 12-month warranty to 18 months**  
and unlock bonus rewards just for registered users.

Scan the QR to register &  
discover your exclusive perks.

SCAN  
ME!



<https://www.rexingusa.com/productreg/>

# Overview

## Thank you for choosing **REXING!**

We hope you love your new products as much as we do. If you need assistance, or have any suggestions to improve it, please contact us.

 care@rexingusa.com

 (877) 740-8004

Our support team will respond to you as soon as possible.

Always a surprise with Rexing

Check us out here.

- <https://www.facebook.com/rexingusa/>
- <https://www.instagram.com/rexingdashcam/>
- <https://www.rexingusa.com/support/registration/>

 Facebook



 Instagram



 Site



 Product Support



# What's in the box?



1



2



3



4



5

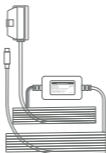

6



8

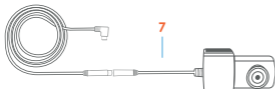

7



9



10

- 
1. R4-RD Quick Start Guide
  2. Safety Guide
  3. Rexing R4-RD Dash Cam
  4. Suction Cup Mount
  5. Cable Management Tool
  6. OBD-NF Smart Hardwire Kit
  7. R4-RD Rear Camera with Extension Cable
  8. Warning sticker
  9. GPS Logger
  10. 64 GB Memory Card
-

# Camera Overview

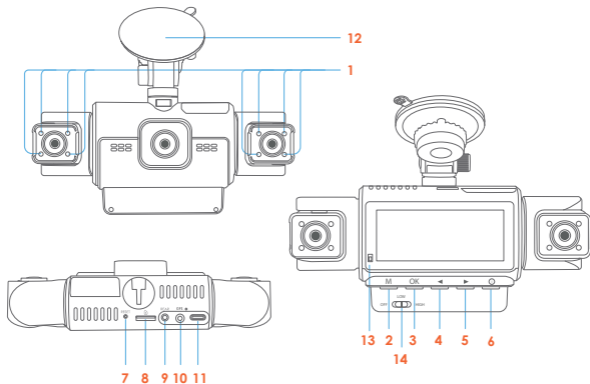

- 1. 8 IR Lights
- 2. Menu Button / Playback Button
- 3. OK (Confirm) Button / Video Lock Button / Wi-Fi Button
- 4. Up Button / Recording / Take Photo
- 5. Down Button / Screen Toggle Button / Mic Button
- 6. Power Button / Screen On/Off
- 7. Reset Button
- 8. Micro SD Card Slot
- 9. Rear Camera Port
- 10. GPS Port
- 11. Charger / Type C Port
- 12. Mounting Area
- 13. The camera is recording when the LED is flashing blue. The device is charging or powered on when the LED is solid blue.
- 14. Radar Sensitivity

# Screen Icons

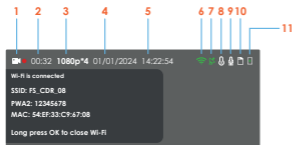

1. Recording (on)
2. Recording Time (current clip)
3. Video Resolution
4. Current Date (MM/DD/YYYY)
5. Time (24h)
6. Wi-Fi (connected)
7. GPS Signal (connected)
8. Current video file locked
9. Audio Recording (on)
10. Memory Card (Inserted)
11. Power Connected



1. Recording (off)
2. Wi-Fi (not connected)
3. GPS Signal (Searching)
4. Audio Recording (off)

# Installation

## Step 1: Install the Suction Cup Mount and Dash Cam

Remove the protective plastic from the suction cup, clean the mounting area of the windshield with rubbing alcohol, and wipe dry with a lint free cloth. Now, clean the back of the suction cup with rubbing alcohol and wipe dry with a lint free cloth. Next, apply moisture to the suction cup to create a better seal and mount the suction cup to the windshield as shown below and **wait approximately 30 minutes** for it to dry. Once dry, attach the device by fitting the tab on the top of the mount into the slot on the top of the device.

Wait at least 20 minutes before mounting the camera.

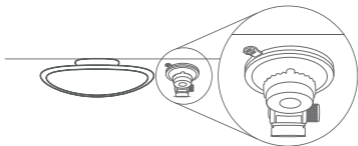

**Orient the mount as shown**

## Step 2: Insert the memory card

The Rexing R4-RD accepts **Class 10/UHS-3 or higher** Micro SD memory cards up to 256GB. You will need to insert a memory card before begin recording. **Before inserting or removing a memory card, first ensure you've powered down the device.** Gently push the memory card in until you hear a click, and allow the spring release to push the card out.

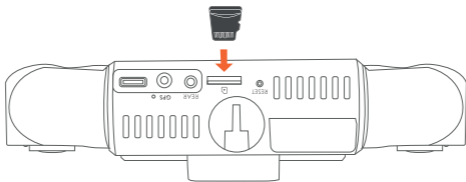

### Step 3: Mount the Rear Camera

Mount the rear camera as shown below. Use rear camera cable to connect the rear camera to the R4-RD camera.

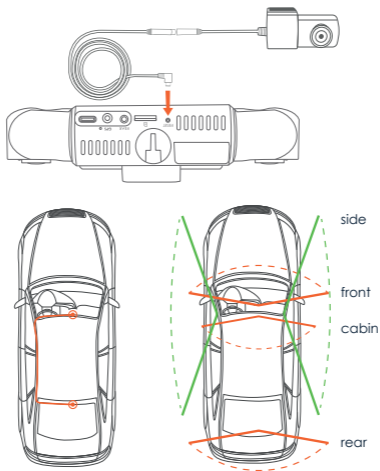

### Step 4: Installing the Camera onto the Windshield

Place the camera on the mount and carefully route the smart hardwire kit around the windscreen and tuck in under the trim.

Connect the smart hardwire kit to the car OBD-II Port, and connect the Type-C port to the dash cam.

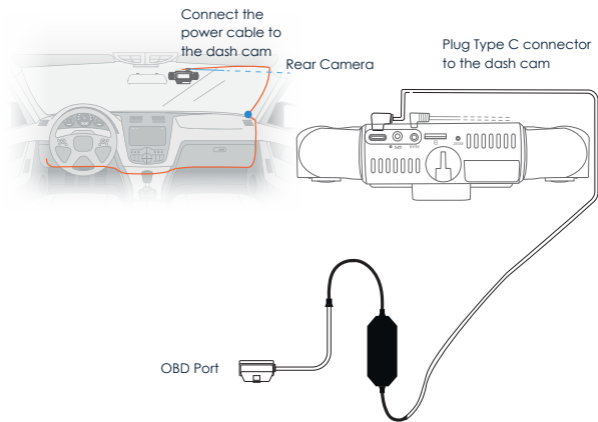

For detailed installation instructions for the Smart Hardwire Kit, please refer to page 17.

## Step 5: Power on the Camera and Format the Memory Card

Power the camera by connecting the smart hardwire kit and camera.

**Before you start using a new memory card, you MUST format the card within the camera using the format function.** Always backup important data

stored on the memory card before formatting.

To format the memory card, make sure you have inserted your memory card, then turn on the device by connecting to a power source. Press  to stop recording. Then press the **MENU** button twice to enter the Menu.

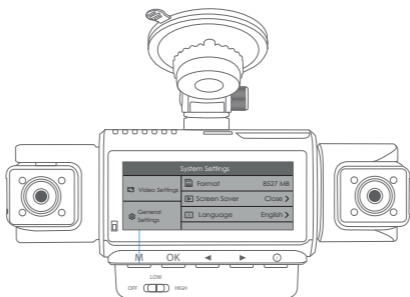

Press the Menu button twice and toggle down to **Format**

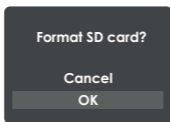

Press the **OK** button to confirm formatting the card

Use the **UP** and **DOWN** navigation buttons and go to the Format setting. Press the **OK** button to confirm the selection. You may now disconnect from power. The camera will shut down after 3 seconds. The camera should begin recording automatically the next time it is powered on.

# Basic Operation

## Device Power

The device will be automatically powered on when vehicle is started.

To turn the device on manually, press and hold the **Power** button until the welcome screen appears.

The camera will automatically start recording when it's powered on.

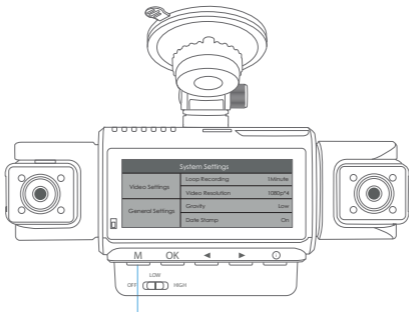

Press and hold the **Power** button to turn the device on manually

## Menu Settings

Power on the camera. If the camera is recording, press the  button to stop recording.

Hold the **MENU** button and toggle to the desired mode.

Press the **MENU** button once to enter the Video Settings.

Press the **MENU** button twice to enter the Setup Settings.

## Video Recording

The camera will automatically start recording when the device receives a charge. The LED lights and red dot will blink red device when recording. Press the **OK** button to stop recording.

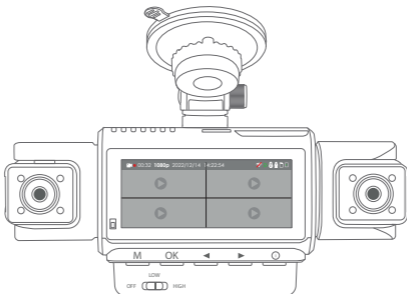

## Video Playback

Playback of videos can be done on the device or a computer. To playback a video on the device, hold **MENU** button and toggle to the Playback mode. Use the **UP** and **DOWN** navigation buttons to toggle to the desired video. Press the **OK** button to play.

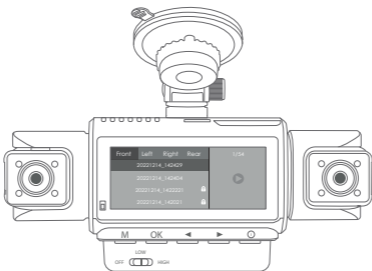

During playback, use the **OK** (pause), **UP** (rewind) and **DOWN** (fast forward) buttons to control the video playback.

To playback a video using an SD card adapter, remove the memory card and insert it into an SD card adapter. Place the adapter in the computer. Then place the adapter into the computer. On the computer, navigate to device drive. Then select the video to playback.

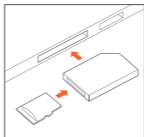

# Wi-Fi Connect

## Step 1:

With your dash cam powered on, hold the **OK** navigation button to enable the Wi-Fi function. The Wi-Fi name (aka the SSID and password for the dash cam should be displayed on-screen.

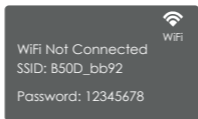

## Step 2:

On your mobile device, navigate to your Wi-Fi settings. Connect to your dash cam's Wi-Fi by tapping its name when it appears. Enter your dash cam's Wi-Fi password if you are prompted to do so.

**Note:** On some mobile devices, you may have to try to connect more than once. To ensure you've successfully connected, your mobile device's screen

### Samsung / Android Example

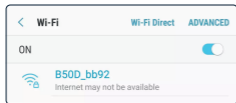

### iPhone / iOS Example



### Step 3:

Once you're connected to the dash cam, open the Rexing Connect app on your mobile device.

Please select "Keep Trying Wi-Fi" if you see the notification on the right.

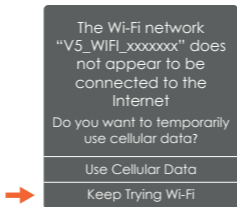

### Step 4:

In the app, hit the "Connect" button to connect to your dash cam, allowing you to access live view and view/download your recordings.

#### Note:

Hold to the **OK** button for 2 seconds to disconnect the

## Rexing Connect App

Easily download the app by scanning the QR code below or search via the App Store or Google Play



## Wi-Fi Connect Troubleshooting

If you bring up the Rexing Connect app and cannot connect your phone to the dash cam please go to <https://www.rexingusa.com/wifi-connect/> OR scan the QR code below.



## GPS Logger

To activate the GPS logger feature, you'll need to connect the GPS logger.

The GPS logger will record the speed and location of your vehicle as you drive.

You can then access these information while playing back your recordings using the GPS Video player. For windows and Mac, available at <https://www.rexingusa.com/support/rexing-apps/>

The dash cam will automatically search for the GPS signal once it's connected to the power source. Press the **MENU** button twice and go to General Settings. Toggle the GPS Speed setting, and select your favorite

After a GPS signal is found, the screen icon will turn from **not connected** to **active** - as per the below icons.



GPS Signal  
Searching



GPS Signal  
Active

## GPS Date-Time Troubleshooting

If your dash cam GPS date and time are incorrect please go to <https://www.rexingusa.com/gps-date-time/> OR scan the QR code below.



## Parking Monitor (Parking Surveillance Mode)

Parking monitor provides surveillance on your parked vehicle. When the engine is off, the hardwire kit is used to provide continuous power and protect your car battery from being discharged.

**The R4-RD features a built-in 360° motion sensor that continuously monitors movement around your vehicle, providing all-around protection while parked. Please follow the steps below to properly activate the parking monitor and motion detection function.**

We kindly suggest taking a moment to watch our tutorial video. It's designed to help you have a smooth and successful installation experience. We believe you'll find it very helpful!

Please go to <https://www.rexingusa.com/ihwkinstall> or scan QR code



### Option 1: Vibration Detection

This feature will allow the dash cam to switch to parking mode automatically if the vehicle's engine turns off and switch back to the normal recording after the vehicle's engine turns on.

### Gravity Sensing Record:

The Gravity Sensing detects significant or sudden movement (such as an impact or collision), it will trigger an event recording.

Please **DO NOT ENABLE** the Parking Monitor function in the settings of the dash cam **WITHOUT** connecting a smart hardwire kit. They may cause a malfunction.

## Option 2: Motion Detection

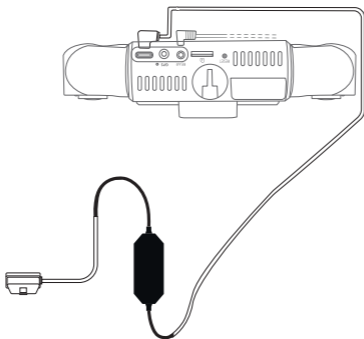

Once the built-in motion sensor has detected **MOTIONS**. The dash cam will power up the dash cam automatically and start recording until the **MOTION** is cleared.

# Warranty & Support

## Warranty

The Rexing R4-RD Dash Cam comes with a full 12-month warranty. If you register your product on our official site (<https://www.rexingusa.com/support/registration>), you can extend the warranty to 18 months.

## Support

If you have any questions regarding your product, please do not hesitate to contact us at [care@rexingusa.com](mailto:care@rexingusa.com), or call us at (877) 740-8004. Queries are typically answered within 12-24 hours.

## Your opinion matters

Rexing is firmly committed to always improving our products, services, and user experience. If you have any thoughts on how we can do even better, we welcome your constructive feedback and suggestions.

Connect with us today at [care@rexingusa.com](mailto:care@rexingusa.com)

**Thank you for choosing Rexing!**

## FCCID: 2AW5W-R4-RD

This device complies with part 15 of the FCC Rules. Operation is subject to the following two conditions: (1) This device may not cause harmful interference, and (2) this device must accept any interference received, including interference that may cause undesired operation.

Changes or modifications not expressly approved by the party responsible for compliance could void the user's authority to operate this equipment.

# REXING®



MADE IN CHINA